

# User Manual



**ninebot<sup>®</sup> KickScooter** **MAX**

## Contents

1 Riding Safety .....	02
2 Packing List .....	04
3 Diagram .....	05
4 Assembling Your KickScooter .....	06
5 First Ride .....	07
6 Charging .....	08
7 Learning to Ride .....	08
8 Warnings .....	10
9 Folding and Carrying .....	14
10 Maintenance .....	15
11 Specifications .....	16
12 Certifications .....	17
13 Trademark and Legal Statement .....	20
14 Contact .....	21

## Thanks for choosing the Ninebot KickScooter Max!

Thanks for choosing the Ninebot KickScooter Max (hereinafter referred to as KickScooter)!

Your KickScooter is a recreational product with mobile app, allowing you to connect with other riders.

Enjoy your ride and connect with riders worldwide!



# 1 Riding Safety

1. The KickScooter is a recreational product. Before mastering riding skills, you need to practice. Neither Ninebot Inc. (means Ninebot (Beijing) Tech Co., Ltd. and its subsidiaries and affiliates) nor Segway Inc. is responsible for any injuries or damage caused by a rider's inexperience or failure to follow the instructions in this document.
2. Please understand that you can reduce the risk by following all the instructions and warnings in this manual, but you cannot eliminate all the risks. Remember that whenever you ride the KickScooter you risk injury from loss of control, collisions, and falls. When entering into public spaces always comply with the local laws and regulations. As with other vehicles, faster speeds require longer braking distance. Sudden braking on low traction surfaces could lead to wheel slip, or falls. Be cautious and always keep a safe distance between you and other people or vehicles when riding. Be alert and slow down when entering unfamiliar areas.
3. Always wear a helmet when riding. Use an approved bicycle or skateboard helmet that fits properly with the chin strap in place, and provides protection for the back of your head.
4. Do not attempt your first ride in any area where you might encounter children, pedestrians, pets, vehicles, bicycles, or other obstacles and potential hazards.
5. Respect pedestrians by always yielding the right of way. Pass on the left whenever possible. When approaching a pedestrian from the front, stay to the right and slow down. Avoid startling pedestrians. When approaching from behind, announce yourself and slow down to walking speed when passing. Please obey local traffic laws and regulations if situation is different.
6. In places without laws comply with the safety guidelines outlined in this manual. Neither Ninebot Inc. nor Segway Inc. is responsible for any property damage, personal injury/death, accidents, or legal disputes caused by violations of the safety instructions.
7. Do not allow anyone to ride your KickScooter on his/her own unless they have carefully read this manual and followed the New Rider Tutorial in the App. The safety of new riders is your responsibility. Assist new riders until they are comfortable with the basic operation of the KickScooter. Make sure each new rider wears a helmet and other protective gear.
8. Before each ride check for loose fasteners and damaged components. If the KickScooter makes abnormal sounds or signals an alarm, immediately stop riding. Diagnose your KickScooter via the Segway-Ninebot App and call your dealer/distributor for service.

9. Be alert! Scan both far ahead and in front of your KickScooter — your eyes are your best tool for safely avoiding obstacles and low traction surfaces (including, but not limited to, wet ground, loose sand, loose gravel, and ice).
10. To reduce risk of injury, you must read and follow all “CAUTION” and “WARNING” notices in this document. Do not ride at an unsafe speed. Under no circumstance should you ride on roads with motor vehicles. The manufacturer recommends riders be 14+ years old. Always follow these safety instructions:
  - A. People who should not ride the KickScooter include:
    - i. Anyone under the influence of alcohol or drugs.
    - ii. Anyone who suffers from disease that puts them at risk if they engage in strenuous physical activity.
    - iii. Anyone who has problems with balance or with motor skills that would interfere with their ability to maintain balance.
    - iv. Anyone whose weight is outside the stated limits (see Specifications).
    - v. Pregnant women.
  - B. Riders under the age of 18 years old should ride under adult supervision.
  - C. Comply with local laws and regulations when riding this product. Do not ride where prohibited by local laws.
  - D. To ride safely, you must be able to clearly see what is in front of you and you must be clearly visible to others.
  - E. Do not ride in the snow, in the rain, or on roads which are wet, muddy, icy, or that are slippery for any reason. Do not ride over obstacles (sand, loose gravel, or sticks). Doing so could result in a loss of balance or traction and could cause a fall.
11. Do not attempt to charge your KickScooter if, the charger, or the power outlet is wet.
12. As with any electronic device, use a surge protector when charging to help protect your KickScooter from damage due to power surges and voltage spikes. Only use the Segway supplied charger. Do not use a charger from any other different product models.
13. Use only Ninebot or Segway approved parts and accessories. Do not modify your KickScooter. Modifications to your KickScooter could interfere with the operation of the KickScooter, could result in serious injury and/or damage, and could void the Limited Warranty.

## 2 Packing List

### Assembled KickScooter

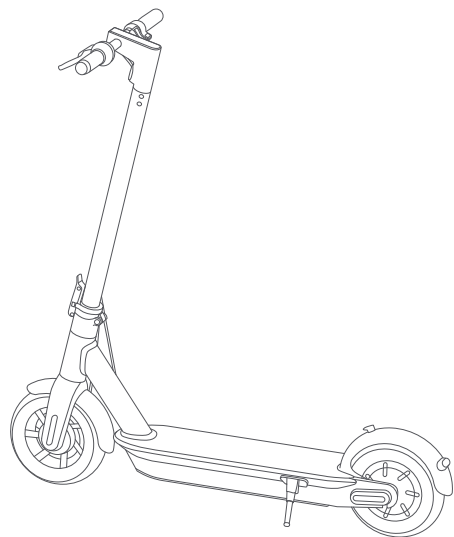

### User Materials



### Accessories

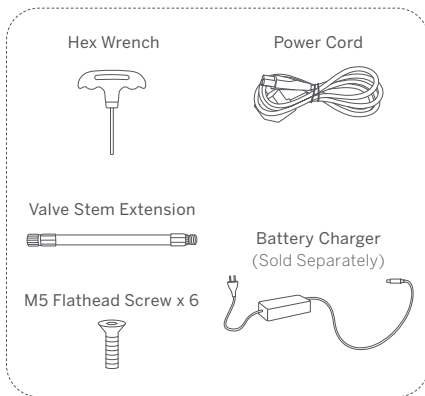

When unpacking your KickScooter, please verify that the above items are included in the package. If you are missing any components, please contact your dealer/distributor or nearest service center (see Contact in the user manual). After verifying that all components are present and in good condition, you can assemble your new KickScooter.

Please retain the box and packaging materials in case you need to ship your KickScooter in the future.

Remember to power off your KickScooter and unplug the power cord before assembling, mounting accessories, or cleaning the mainframe.

## 3 Diagram

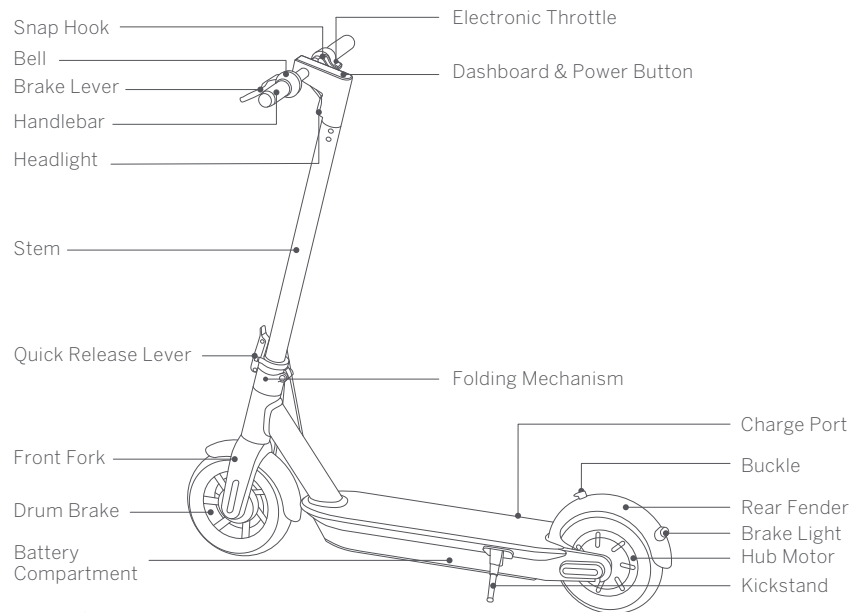

### Dashboard & Power Button

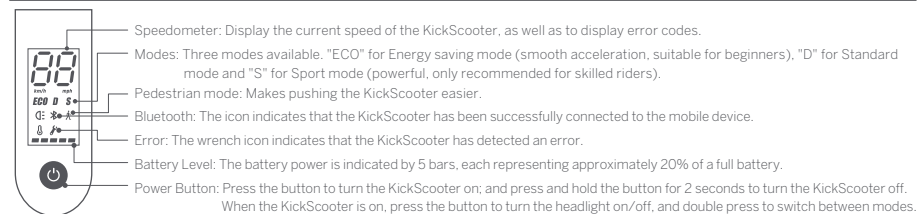

## 4 Assembling Your KickScooter

1. Unfold the handlebar stem and fasten it. Then unfold the kickstand to support the KickScooter.

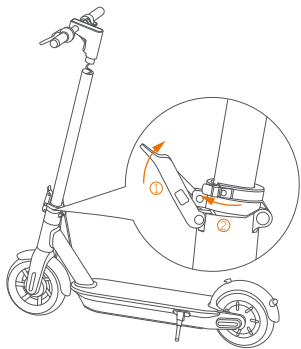

2. Firmly connect the wires inside the handle and the stem. Slide the handle onto the stem. Be aware of the correct orientation.

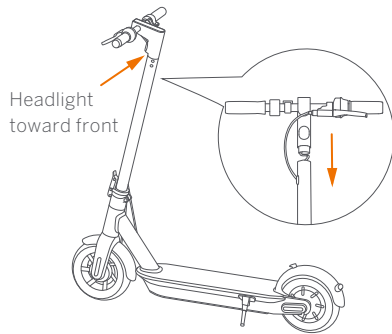

3. Install six screws (two on each side) with the included hex wrench.

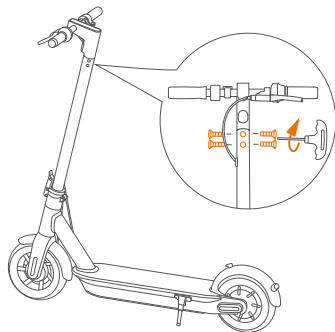

4. Verify that your KickScooter can be powered on and off.

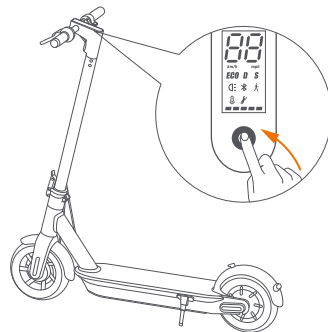

## 5 First Ride

▲ There are safety risks when learning to ride the KickScooter. You must read the Riding Safety via the App before your first ride.



Segway-Ninebot App

For your safety, your new KickScooter is not activated and will beep occasionally after Power ON.

Until activated, the KickScooter maintains very low riding speed, and cannot be ridden with full function. Install the App on your mobile device (with Bluetooth 4.0 or above), connect to the KickScooter with Bluetooth, and follow the App instructions to activate your KickScooter and enjoy the full performance.

Scan the QR code to download the App.

1. Install the App and register/login.

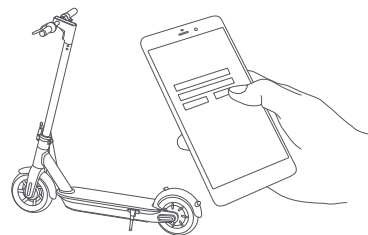

2. Power on the KickScooter. A blinking Bluetooth icon indicates the KickScooter is waiting for a connection.

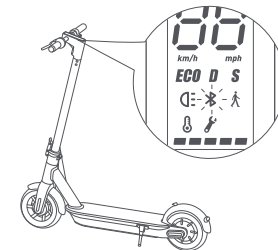

3. Click "Vehicle" → "Scan for Vehicle" to connect to your KickScooter. The KickScooter will beep when the connection is successful. The Bluetooth icon will stop blinking and remain illuminated.

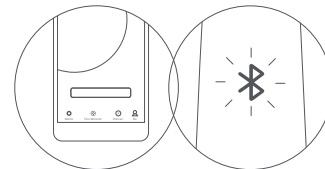

4. Follow the App instructions to activate the KickScooter and learn how to ride safely. You can now start to use your KickScooter, check the status with App, and interact with other users. Have fun!

## 6 Charging

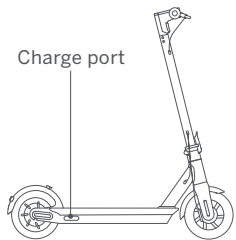

### Charging step tips



### ▲ WARNING

Do not charge if the charge port or power cord is wet.

Do not charge or use your battery if it is damaged or see trace of water.

Close the charge port cover when not charging.

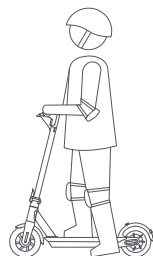

2. Stand on the footrest with one foot and push off with another foot to start gliding.

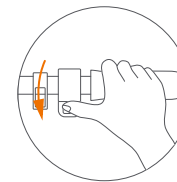

3. Put your other foot on the footrest to keep both feet stable. Press the throttle on the right hand to speed up when you are balanced.

Note, for your safety, the motor will not engage until the KickScooter reaches 3.1 mph (5 km/h).

## 7 Learning to Ride

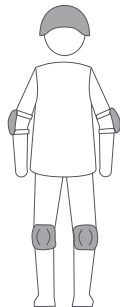

Wear an approved helmet and other protective gear to minimize any possible injury.

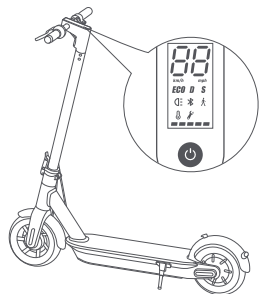

1. Power on the KickScooter and check the power level indicator. Charge the KickScooter if the battery level is low.

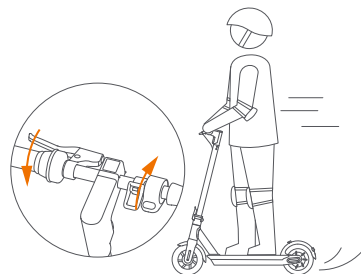

4. Slow down by releasing the throttle; and brake by squeezing the brake lever.

### ▲ WARNING

When hard braking, you risk serious injury due to loss of traction and falls. Maintain a moderate speed and look out for potential hazards.

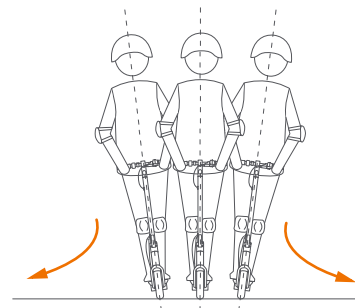

5. To turn, shift your body weight and turn the handle slightly.

## 8 Warnings

**⚠ WARNING**  
Failure to follow these instructions could lead to serious injury.



**⚠** DO NOT ride the KickScooter in the rain. DO NOT get wet.



**⚠** DO NOT ride over speed bumps, thresholds, or other bumps at HIGH SPEED.

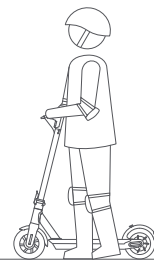
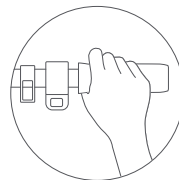

**⚠** DO NOT press the throttle when walking with the KickScooter.

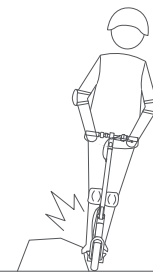

**⚠** Avoid contacting obstacles with the tire/wheel.

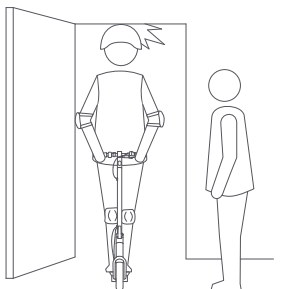

**⚠** Watch your head when passing through doorways.



**⚠** Do not keep your feet on the rear fender.

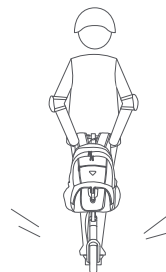

**⚠** DO NOT carry heavy objects on the handlebar.

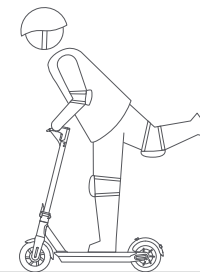

**⚠** DO NOT ride the KickScooter with only one foot.

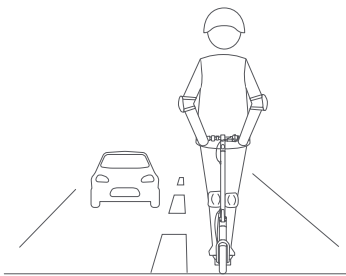

⚠ DO NOT ride on public roads, motorways, or highways.

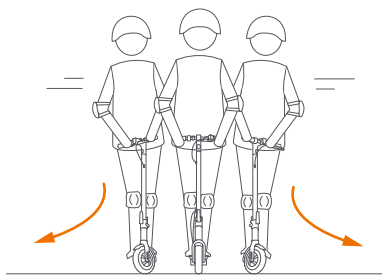

⚠ DO NOT rotate the handle violently while driving at high speed.

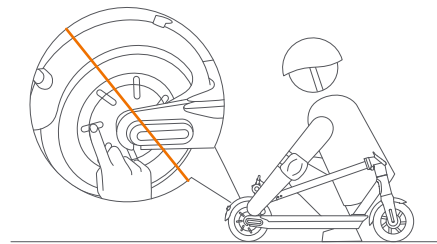

⚠ DO NOT touch the hub motor after riding because it can get hot.



⚠ DO NOT take your hands off the handlebar while riding. Do not ride with one hand only.



⚠ DO NOT ride through puddles or other bodies of water.

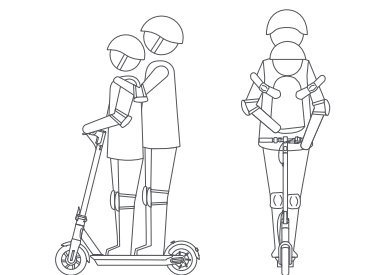

⚠ The KickScooter is for one rider only. Do not carry any passengers. Do not carry a child. Do not ride when pregnant.

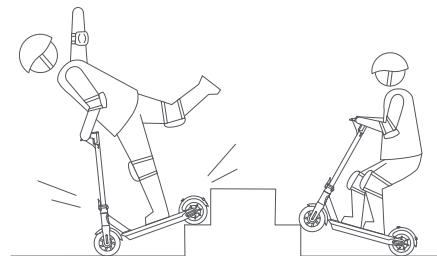

⚠ DO NOT ride up and down stairs or jump over obstacles.



⚠ Do not use mobile phone or wear earphones when operating the KickScooter.

**⚠ WARNING**  
Always keep both hands on the handlebar or you risk serious injury due to loss of balance and falls.



## 9 Folding and Carrying

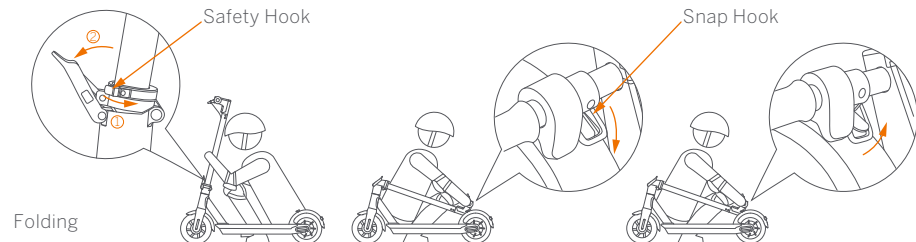

Folding

Turn off your KickScooter. Turn the safety hook counterclockwise and open the quick release lever.

Align the snap hook and the buckle and hook them.

Disengage the snap hook from the buckle. Fold the handlebar stem up, close the quick release lever and turn the safety hook clockwise.

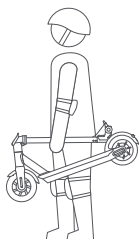

Carrying

When your KickScooter is folded up, lift it by the stem to carry.

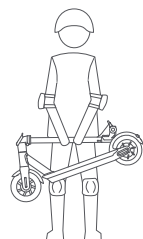

## 10 Maintenance

### Cleaning and Storage

Use a soft, wet cloth to wipe the mainframe clean. Dirt hard to remove can be scrubbed with a toothbrush and toothpaste, then cleaned with a soft, wet cloth.

### NOTE

Do not wash your KickScooter with alcohol, gasoline, acetone, or other corrosive/volatile solvents. These substances may damage the appearance and internal structure of your KickScooter. Do not wash your KickScooter with a power washer or hose.

### ⚠ WARNING

Make sure the KickScooter is powered OFF, the power cord is unplugged, and the rubber cap on the charge port is tightly sealed before cleaning; otherwise you may damage the electronic components.

Store your KickScooter in a cool, dry place. Do not store it outdoors for extended periods of time. Exposure to sunlight and temperature extremes (both hot and cold) will accelerate the aging process of the plastic components and may reduce battery life.

### Tire Pressure

Inflate tires to 32–37 psi. Inflate both tires equally.

### Battery Pack Maintenance

Do not store or charge the battery at temperatures outside the stated limits (see Specifications). Do not puncture the battery. Refer to your local laws and regulations regarding battery recycling and/or disposal.

A well maintained battery can perform well even after many miles of riding. Charge the battery after each ride and avoid draining the battery completely. When used at room temperature (70°F [22°C]) the battery range and performance is at its best; whereas using it at temperatures below 32°F (0°C) can decrease range and performance. Typically, at -4°F (-20°C) range can be half that of the same battery at 70°F (22°C). Battery range will recover when temperature rises. More details are available in the App.

### NOTE

Typically, a fully charged battery should retain power for 120-180 days. A low-power battery should retain power for 30–60 days. Remember to charge the battery after each use. Completely draining the battery may cause permanent damage to the battery. Electronics inside the battery record the charge-discharge condition of the battery; damage caused by over-charging or under-charging will not be covered by the Limited Warranty.

### ⚠ WARNING

Do not attempt to disassemble the battery. Do not touch battery contacts. Do not dismantle or puncture the casing. Keep the battery contacts away from metal objects to prevent short circuit. Risk of fire and electric shock. No user serviceable parts. Do not charge or use your battery if it is damaged or see trace of water.

### ⚠ WARNING

Do not ride when the ambient temperature is outside the machine operation temperature (see Specifications) because low/high temperature will limit the maximum power/torque. Doing so could cause personal injury or property damage due to slips or falls.

## 11 Specifications

	Item	G30
Dimensions	Unfold: Length x Width x Height	~ 45.9 × 18.6 × 47.4 in (1167 × 472 × 1203 mm)
	Fold: Length x Width x Height	~ 45.9 × 18.6 × 21.0 in (1167 × 472 × 534 mm)
Weight	Net	Approx. 41.2 lbs (18.7 kg)
Rider	Payload	66.1–220.5 lbs (30.0–100.0 kg)
	Recommended Age	14+ years
	Required Height	3'11"–6'6" (120–200 cm)
Machine Parameters	Max. Speed	Approx. 15.5 mph (25 km/h)
	Typical Range <sup>[1]</sup>	Approx. 40.4 miles (65 km)
	Max. Slope	Approx. 15%
	Traversable Terrain	asphalt/flat pavement; obstacles < 0.4 in (1 cm); gaps < 1.2 in (3 cm)
	Operating Temperature	14–104°F (-10–40°C)
	Storage Temperature	-4–122°F (-20–50°C)
	IP Rating	IPX5
	Duration of Charging	~ 6 h
Battery	Nominal Voltage	36 VDC
	Max. Charging Voltage	42 VDC
	Charging Temperature	32–104°F (0–40°C)
	Nominal Capacity	551 Wh
	Battery Management System	Over-heating, short circuit, over-current and over-charge protection
	Number Of Batteries	1
Motor	Nominal Power	350 W
Charger	Output Power	121 W
	Input Voltage	100–240V ~ 50/60Hz
	Output Voltage	42 VDC
	Output Current	2.9 A
Features	Brake Light	LED rear light
	Riding Modes	Energy Saving mode, Standard mode and Sport mode

[1] Typical Range: tested while riding under full power, 165.3 lbs (75.0 kg) load, 77°F (25°C), 9.3 mph (15 km/h) on average on pavement.

## 12 Certifications

### Federal Communications Commission (FCC) Compliance Statement for USA

This device complies with part 15 of the FCC rules. Operation is subject to the following two conditions: (1) This device may not cause harmful interference, and (2) this device must accept any interference received, including interference that may cause undesired operation.

#### NOTE

This equipment has been tested and found to comply with the limits for a Class B digital device, pursuant to part 15 of the FCC Rules. These limits are designed to provide reasonable protection against harmful interference in a residential installation. This equipment generates, uses and can radiate radio frequency energy and, if not installed and used in accordance with the instructions, may cause harmful interference to radio communications. However, there is no guarantee that interference will not occur in a particular installation. If this equipment does cause harmful interference to radio or television reception, which can be determined by turning the equipment off and on, the user is encouraged to try to correct the interference by one or more of the following measures:

- Reorient or relocate the receiving antenna.
- Increase the separation between the equipment and receiver.
- Connect the equipment into an outlet on a circuit different from that to which the receiver is connected.
- Consult the dealer or an experienced radio/TV technician for help.

This equipment complies with FCC radiation exposure limits set forth for an uncontrolled environment.

### Industry Canada (IC) Compliance Statement for Canada

This device complies with Industry Canada license-exempt RSS standard (s). Operation is subject to the following two conditions: (1) this device may not cause interference, and (2) this device must accept any interference, including interference that may cause undesired operation of the device.

#### CAN ICES-3 (B)/NMB-3(B)

"Le présent appareil est conforme aux CNR d'Industrie Canada applicables aux appareils radio exempts de licence. L'exploitation est autorisée aux deux conditions suivantes : (1) l'appareil ne doit pas produire de brouillage, et (2) l'utilisateur de l'appareil doit accepter tout brouillage radioélectrique subi, même si le brouillage est susceptible d'en compromettre le fonctionnement."

Neither Segway Inc. nor Ninebot is responsible for any changes or modifications not expressly approved by Segway Inc. or Ninebot. Such modifications could void the user's authority to operate the equipment.

FCC ID: 2ALS8-NB9676  
IC: 22636-NB9676

### Important WEEE information



WEEE Disposal and Recycling Information Correct Disposal of this product. This marking indicates that this product should not be disposal with other household wastes throughout the EU.

To prevent possible harm to the environment or human health from uncontrolled waste disposal, recycle it responsible to promote the sustainable reuse of materials resources. To return your used device, please use the return and collection systems or contact the retailer where the product was purchased. They can take this product for environmental safe recycling.

### Battery recycling information for the European Union



Batteries or packaging for batteries are labeled in accordance with European Directive 2006/66/EC and amendment 2013/56/EU concerning batteries and accumulators and waste batteries and accumulators. The Directive determines the framework for the return and recycling of used batteries and accumulators as applicable throughout the European Union. This label is applied to various batteries to indicate that the battery is not to be thrown away, but rather reclaimed upon end of life per this Directive.

In accordance with the European Directive 2006/66/EC and amendment 2013/56/EU, batteries and accumulators are labeled to indicate that they are to be collected separately and recycled at end of life. The label on the battery may also include a chemical symbol for the metal concerned in the battery (Pb for lead, Hg for mercury, and Cd for cadmium).

Users of batteries and accumulators must not dispose of batteries and accumulators as unsorted municipal waste, but use the collection framework available to customers for the return, recycling, and treatment of batteries and accumulators. Customer participation is important to minimize any potential effects of batteries and accumulators on the environment and human health due to the potential presence of hazardous substances.

Before placing electrical and electronic equipment (EEE) in the waste collection stream or in waste collection facilities, the end user of equipment containing batteries and/or accumulators must remove those batteries and accumulators for separate collection.

### Restriction of Hazardous Substances (RoHS) Directive

This Ninebot (Changzhou) Tech Co., Ltd. product, with included parts (cables, cords, and so on) meets the requirements of Directive 2011/65/EU on the restriction of the use of certain hazardous substances in electrical and electronic equipment ("RoHS recast" or "RoHS 2").

### Radio Equipment Directive



### Segway Europe BV, Hogehilweg 8, 1101 CC Amsterdam, The Netherlands.

Hereby, Ninebot (Changzhou) Tech Co., Ltd. declares that the wireless equipment listed in this section are in compliance with the essential requirements and other relevant provisions of Directive 2014/53/EU.

Bluetooth	Frequency Band(s)	2.4000–2.4835GHz
	Max. RF Power	100mW

## 13 Trademark and Legal Statement

Ninebot is the registered trademark of Ninebot (Tianjin) Tech. Co., Ltd; Segway and the Rider Design are the registered trademarks of Segway Inc.; Android, Google Play are trademarks of Google Inc., App Store is a service mark of Apple Inc., The respective owners reserve the rights of their trademarks referred to in this manual.

The KickScooter is covered by relevant patents. For patent information go to <http://www.segway.com>.

We have attempted to include descriptions and instructions for all the functions of the KickScooter at the time of printing. However, due to constant improvement of product features and changes of design, your KickScooter may differ slightly from the one shown in this document. Visit the Apple App Store (iOS) or the Google Play Store (Android) to download and install the App.

Please note that there are multiple Segway and Ninebot models with different functions, and some of the functions mentioned herein may not be applicable to your unit. The manufacturer reserves the right to change the design and functionality of the KickScooter product and documentation without prior notice.

© 2019 Ninebot (Beijing) Tech Co. Ltd. All rights reserved.

## 14 Contact

**Contact us if you experience issues relating to riding, maintenance and safety, or errors/faults with your KickScooter.**

### **Americas:**

#### **Segway Inc.**

14 Technology Drive, Bedford, NH 03110, USA

Tel: 1-603-222-6000

Fax: 1-603-222-6001

Toll Free: 1-866-473-4929

E-mail Sales: [customeroperation@segway.com](mailto:customeroperation@segway.com)

E-mail Service: [technicalsupport@segway.com](mailto:technicalsupport@segway.com)

Website: [www.segway.com](http://www.segway.com)

### **Europe, Middle East and Africa:**

#### **Segway Europe B.V.**

Hogehilweg 8, 1101CC Amsterdam, The Netherlands

Website: [www.segway.com](http://www.segway.com)

### **Have your KickScooter serial number on hand when contacting Segway.**

You can find your serial number on the underside of your KickScooter or in the App under More Settings -> Basic Information.