

Mi 4K Laser Projector 150" User Manual



Table of Contents

User Notice	4	Bluetooth Speakers	19
Legal Notice.....	4	Care & Maintenance	20
Laser Safety Information	5	Heat Dissipation Maintenance	20
Safety Instructions	5	Cleaning & Maintenance	20
Package Contents	8	Specifications	21
Product Overview	9	Troubleshooting	23
Exterior	9	Product Certifications	24
Connection Ports	10		
Power Indicator	11		
Remote Control	12		
Projection Distance & Screen Size.....	13		
Suspended Ceiling Installation	14		
Quick Start Guide	15		
Pairing the Remote Control	15		
Image Focus.....	16		
Keystone Correction	16		
Network & Internet.....	17		
Smart Temperature Control	17		
Safety & Protection	18		

User Notice

Thank you for choosing the Mi 4K Laser Projector 150".

Read this manual carefully before use, and retain it for future reference.

Illustrations of product, accessories, and user interface in the user manual are for reference purposes only. Actual product and functions may vary due to product enhancements.

Legal Notice



All products bearing this symbol are waste electrical and electronic equipment (WEEE as in directive 2012/19/EU) which should not be mixed with unsorted household waste. Instead, you should protect human health and the environment by handing over your waste equipment to a designated collection point for the recycling of waste electrical and electronic equipment, appointed by the government or local authorities. Correct disposal and recycling will help prevent potential negative consequences to the environment and human health. Please contact the installer or local authorities for more information about the location as well as terms and conditions of such collection points.



Hereby, Fengmi (Beijing) Technology Co., Ltd declares that the radio equipment type Mi 4K Laser Projector 150" is in compliance with Directive 2014/53/EU. The full text of the EU declaration of conformity is available at the following internet address:

<http://www.mi.com/global/service/support/declaration.html>

This device is restricted to indoor use when operating in the 5150 to 5350 MHz frequency range.

Operating Frequency: 2.4 GHz–2.4835 GHz (for Bluetooth)

Maximum RF Power Output: < 20 mW (for Bluetooth)

Operating Frequency: 2.4 GHz–2.4835 GHz (for Wi-Fi 2.4 GHz)

Maximum RF Power Output: < 100 mW (for Wi-Fi 2.4 GHz)

Operating Frequency: 5.15 GHz–5.35 GHz and 5.47 GHz–5.725 GHz (for Wi-Fi 5 GHz)

Maximum RF Power Output: < 200 mW (for Wi-Fi 5 GHz)



Note: Under normal use of condition, this equipment should be kept a separation distance of at least 20 cm between the antenna and the body of the user.

Laser Safety Information

Laser Information Label

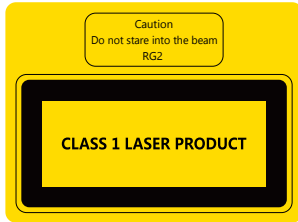

The product complies with IEC 60825-1:2014 Class 1 and RG2 IEC 62471-5:2015.
As with any bright light source, do not stare into the beam, RG2 IEC 62471-5:2015

Safety Instructions

Before using the product, please carefully read the following safety instructions.

Safety Label Description



This warning symbol informs the user that this product contains non-insulated voltage sources that can cause an electric shock. Coming into contact with any internal component may result in an electric shock.



This symbol informs the user about important handling and maintenance related information. Please read this information carefully to ensure proper use.



This symbol informs the user to be aware of high temperatures.



This symbol informs the user to avoid touching this part.



Grounding Warning: This product must be grounded when in use.



Transportation Instructions: It is recommended to transport this projector in its original or similar packaging.



Preventing Electric Shocks and Fire Hazards:

- Using an incorrect power cord may result in decreased product performance and even electric shock or fire. To ensure the projector's performance and safety, only use its original power cord or an identical replacement.
- If you use an extension cord, it must not have a current rating lower than the projector's original power cord. Failure to heed this warning may result in the extension cord overheating and could pose hazards such as electric shock and fire.
- To avoid damage caused by a power surge or lightning strike, unplug the projector from the power outlet during thunderstorms or when it is not in use for a long time.
- Do not place any flammable objects near this projector so as to avoid fire.
- Do not block the lens with any object when the projector is turned on. Any object placed close to the lens may get very hot and/or deformed, and may even cause a fire.
- Do not block any of the vents of the projector, as this may cause a buildup of heat within the product and result in a fire.



Safety Precautions:

- Do not place this projector on an unstable platform, stand or table so as to prevent it from falling and causing serious damage or personal injury.
- Do not look directly into the lens when the projector is turned on to avoid eye damage.
- Do not attempt to disassemble this projector as it may contain dangerous high voltage components. This projector must only be maintained and repaired by a qualified or authorized technician.

- Do not place this projector in an upright position, as it may fall over and cause injury or damage.
- Do not expose this projector to rain or moisture (operating humidity is 20%–80%).
- Do not immerse this projector in, nor expose it to water or other liquids. Immediately unplug the projector if any liquid or object got into its housing, and have it checked by a qualified technician before using it again.
- Do not place this projector in any of the following environments:
 - In poorly ventilated or narrow spaces.
 - Near devices that produce a strong magnetic field.
 - In direct sunlight.
 - Close to a fire alarm.
 - In extremely hot, cold or humid environments.

Package Contents

When opening the packaging, check the contents of the box against the list below. If there is anything missing, please contact the seller in time.

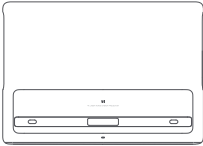

Laser Projector



Remote Control



Power Cord



User Manual



Warranty Notice



Cleaning Cloth



Note:

- The actual contents may vary depending on the country (or region) of sale, please refer to the actual product.
- Retain the original packaging for future storage or transportation.

Product Overview

Exterior

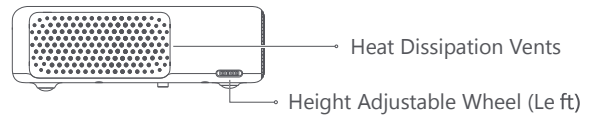
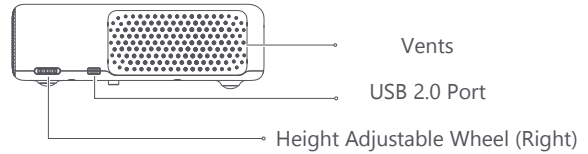
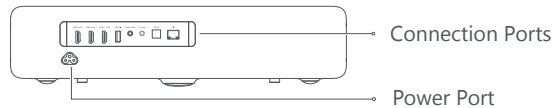
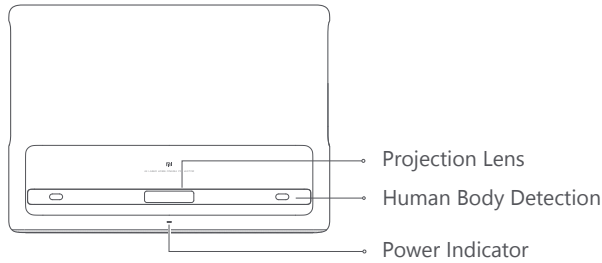

- Do not place any flammable objects near the heat dissipation vent.
- Do not place any objects near the vents, as this may cause heat to build up inside the projector.
- Do not look directly into the lens so as to avoid eye damage as this projector emits strong light during use.

Connection Ports

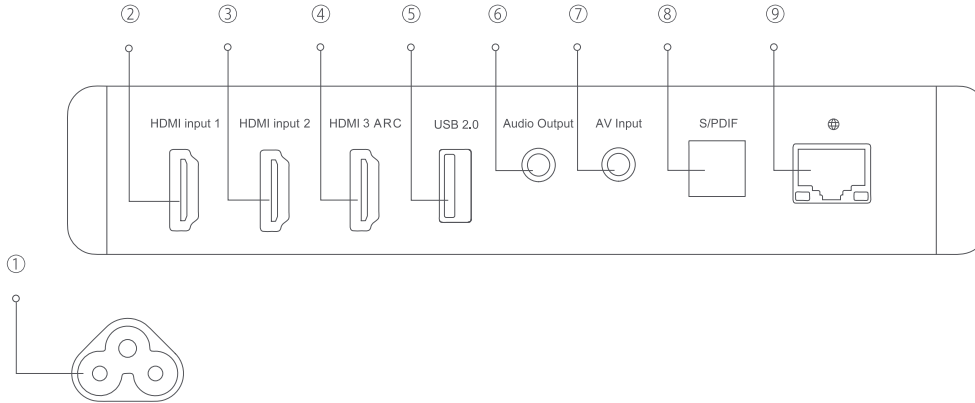

① Power Port

② HDMI input port 1

③ HDMI input port 2

④ HDMI input port 3

Audio return channel port

⑤ Supports USB 2.0 communication protocol

⑥ Audio output port (supports subwoofers)

⑦ AV input port (3.5 mm composite AV port)

⑧ Optical digital audio signal output port

⑨ Ethernet port

Power Indicator

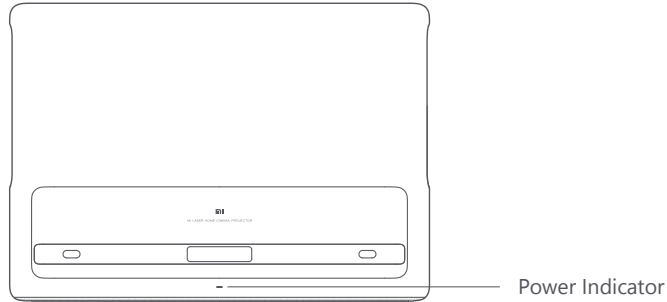

The power indicator (a white light) to the corresponding projector's status is as follows:

- Connect to the power outlet, the projector automatically turns on.
- The indicator blinks when the projector is turning on.
- The indicator turns on after the project is turned on.
- The indicator blinks when the projector is turning off.
- The indicator turns on after the projector is turned off.

Remote Control

Power Button:

When the projector is turned off, press to turn on. When the projector is on, press to select Power, Restart, Bluetooth speaker mode or Screenshot.

Directional Pad (Up):
Move Up

Directional Pad (Left):
Move Left

App:
Access the app interface

Volume + :
Increase the volume

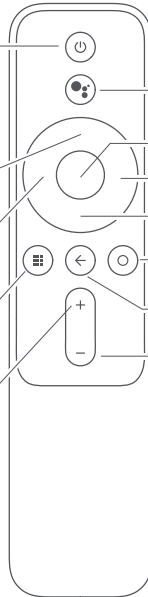

Google Assistant:

Press the Assistant button on your remote to talk to Google Assistant

OK: Confirm the selected option or setting

Directional Pad (Right): Move Right

Directional Pad (Down): Move Down

Home: Return to the home screen

Return: Return to the previous menu

Volume - : Decrease the volume

Battery Cover:

Slide down the battery cover, and install or replace the batteries with two new AAA batteries.

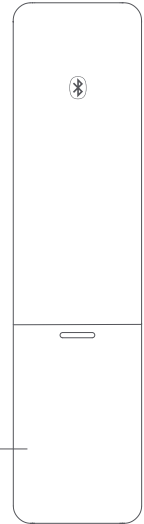

Note:

Note: With Mi 4K Laser Projector 150" and the Google Assistant, quickly access entertainment, control smart devices, get answers on screen, and more using your voice.

- Pay attention to the positive and negative poles when installing batteries in the remote control.
- When battery leaks, immediately wipe away any fluid with a dry cloth and replace the batteries with new ones.
- Dispose of used batteries according to local waste disposal rules and regulations of the country or area you live in.

Projection Distance & Screen Size

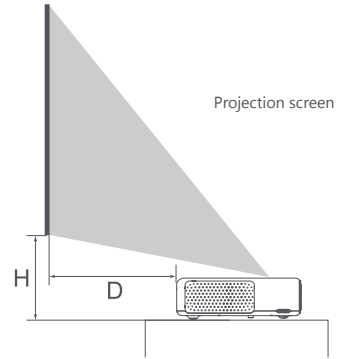
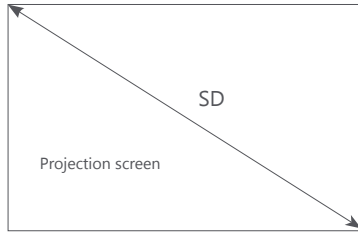

Determine the distance between the projector and the wall or screen according to the desired screen size.

Screen Dimensions (SD)	Projection Distance (D)	Relative Height (H)
80"	14 cm	29 cm
90"	19 cm	32 cm
100"	24 cm	35 cm
120"	34 cm	41 cm
150"	49 cm	50 cm

Screen Dimensions (SD):

The diagonal size of the projection screen (in inches).

Projection Distance (D):

The distance between the projector and the wall or screen (in cm).

Relative Height (H):

The distance from the bottom of the projector to the bottom edge of the projected image (in cm).

Note: The dimensions in the table above are for reference only, they are approximate and may slightly differ from the actual values.

Suspended Ceiling Installation

Suspended ceiling installation is one of the installation methods that you hang the projector in an overhead location, for example, on a high ceiling, through a ceiling mount. A projector supporting suspended ceiling installation has threaded holes on the bottom, you can install the project on the mount by attaching the screws into the holes.

The installation steps are as follows:

1. Install the mount.

Make sure the mount used to install the projector onto can support at least five times the weight of the projector. It requires a professional to carry out the installation.

2. When installing the projector onto a ceiling mount, make sure the screws meet the following specifications:

Screw Type: Non self-tapping screw M4 × 10 (diameter: 4 mm, length: 10 mm), 4 pcs.

Assembly Dimensions: See the figure on the right.

3. Adjust the mount depending on your needs and firmly fix the screws to complete the installation.

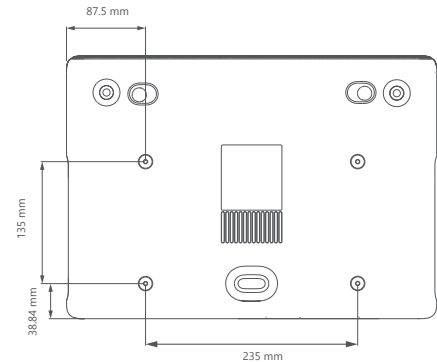

Cautions:

- To avoid the convective heat transfer between the air inlets and air outlets, make sure there are no obstructions within 50 cm of the air inlets and heat dissipation vents.
- Keep the bottom of the projector 10 cm away from the ceiling when suspending it.
- Damage caused by incorrect installation will void the warranty.

Quick Start Guide

Pairing the Remote



After installing the batteries in the remote control, press the OK button to start pairing.

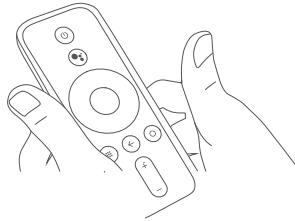
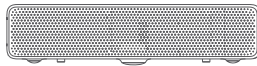

Place the remote control close to the bottom right corner of the projector, then simultaneously press and hold the Home and the App buttons. Release the buttons once you hear a beep, then the remote control is pairing with the projector. Ensure they are close to each other until the pairing completes.

Note: Keep the remote control within 20 cm of the projector during the pairing process.

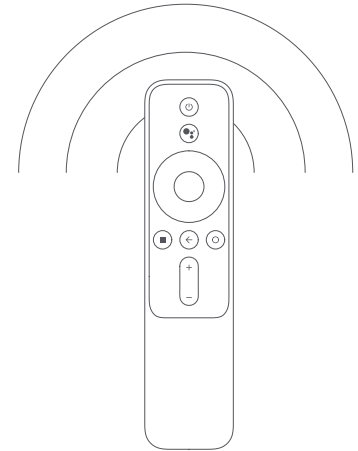

A notification will appear on the projected image once the remote control has been paired successfully.

Image Focus

Go to Settings > Image > Focus, press the left and right button on the remote control to manually fine tune.

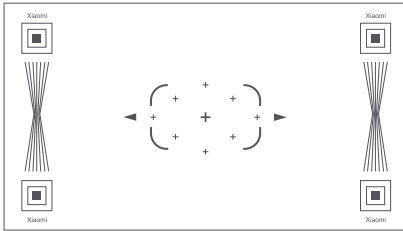

Keystone Correction

To perform keystone correction, go to Settings > Image > Keystone Correction. Use the Left and Right remote buttons to select 8-Point Keystone Correction, Fine Tune, or Reset. Press the OK button to select a mode, then use the remote's directional pad to adjust the shape of the projected image.

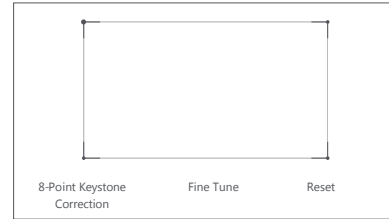

Network & Internet

Go to Settings > Network & Internet. Select a wireless network to connect to, enter the password, and wait for the projector to connect.

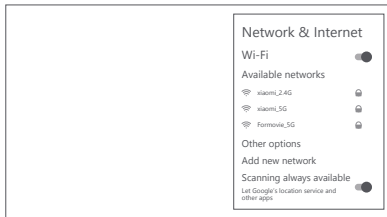

Smart Temperature Control

The projector automatically monitors the ambient temperature (operating temperature range is 0°C to 40°C), projector temperature, and color wheel temperature, and the projector's fan speed is automatically adjusted based on the detected temperature values.

- The projector has three brightness modes to choose from when operating at a normal temperature. To adjust the projector's brightness level, go to Settings > Image > Brightness Mode.
- If the projector gets too hot, an overheating warning will appear and the projector will automatically switch to low brightness mode. Temperature and error warnings will be displayed automatically whenever the temperature exceeds its maximum range to inform you that the projector will be automatically turned off.

Safety & Protection

The projector comes with an infrared sensor which is able to intelligently detect and protect the human eye from damage caused by strong light within the projected area.

The projector will reduce its brightness to the lowest possible value when the sensor is triggered and issue the following notification: "Do not look directly at the light source." Press any button on the remote to exit.

Human infrared sensor & fresnel optical lens

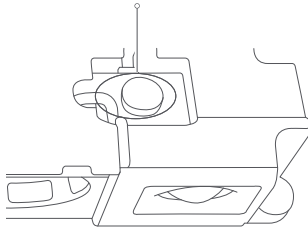

Front sensor range: Approximately 55°

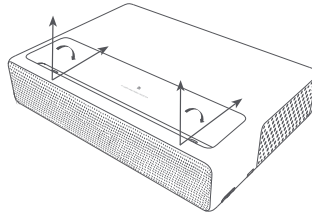

Left and right side sensor range: Approximately 70°

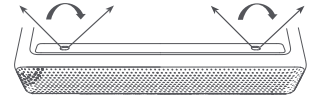

Bluetooth Speakers

The projector has four high-quality built-in speakers with a total output of about 30 W. The speakers can also be used as a standalone Bluetooth stereo.

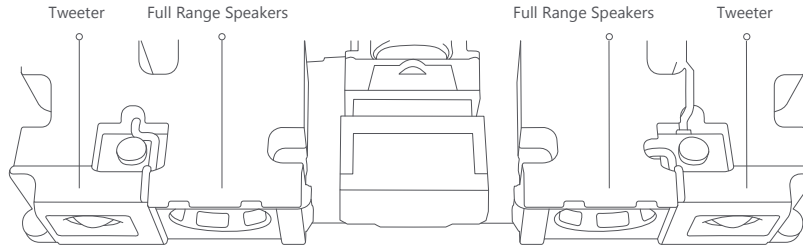

To use speakers as the Bluetooth stereo, press the Home button, then select Settings > Remotes & Accessories > Bluetooth speaker mode from the home screen. Enable the Bluetooth function on your phone. Search and locate the projector name in the Bluetooth list, then pair the projector with your phone.

Note:

To connect and pair with other Bluetooth devices such as speakers and earphones, select Settings > Remotes & Accessories > Add accessory. Make sure the device is in an awaiting connection mode with its Bluetooth function enabled.

Care & Maintenance

Heat Dissipation Maintenance

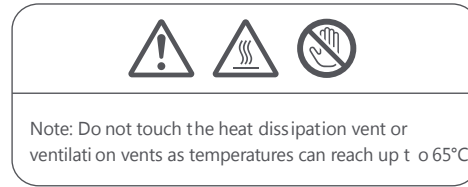
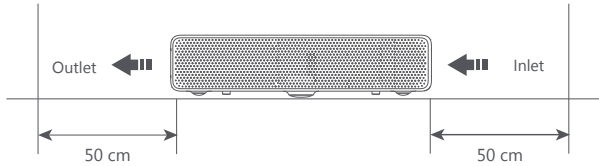

Note: Do not place any objects within 50 cm of the projector's air vents, as this will affect its heat dissipation effect.

Cleaning & Maintenance

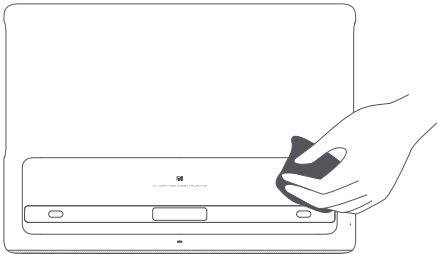

Turn off and unplug the projector before cleaning.

Only use the cleaning cloth that comes with the projector or a professional grade cleaning cloth to clean the projector's glass. Do not use any abrasive cleaning products, solvents, chemicals, or other rough objects so as to avoid scratches or corrosion.



Note:

- The projector is not water resistant. Do not allow liquids to penetrate the projector, especially areas such as the power indicator, glass cover, air vents, connection ports, and speaker grilles.
- Only use the cleaning cloth that comes with the projector or a professional grade cleaning cloth to clean the projector's lens.

Specifications

Basic Information	Name	Mi 4K Laser Projector 150"
	Model	XMJGYDS01FM
	Item Dimensions	410 × 291 × 88 mm
	Net Weight	7.0 kg
Electrical Specifications	Power Consumption	< 300 W (High Brightness Mode)
	Rated Input	100–120/200–240 V ~, 3/2.5 A, 50/60 Hz
	Standby Power Consumption	< 0.5 W
Optical Parameters	Display Technology	0.47" DMD
	Light Source Technology	ALPD
	Standard Resolution	4K (3840 × 2160)
Projection Parameters	Throw Ratio (TR)	0.233 (*actual result may vary)
	Screen Size	80" to 150"
	Lens Focus	Motor Focus
	Keystone Correction	8-point Keystone Correction
RAM	RAM	2GB DDR3
	Built-in Storage	16 GB eMMC High-speed Flash Memory
System Software	Operating System	Android TV
	App	Pre-installed Third-party Apps
	Brightness Mode	High Brightness Mode, View Mode
	Bluetooth	Bluetooth 4.1/BLE

Speaker Audio	Audio Effects	Dolby Audio/DTS-HD
	Speaker	Full Range × 2/Tweeters × 2
Power Supply	Built-in Power Supply	Built-in AC-DC, DC-DC
Safety & Protection	Smart Temperature Control	Automatic Brightness Adjustment/Smart Fan Speed Adjustment
	Temperature Switch	Overheating Auto Turn-off
	Laser Projector Eye Protection	Human Body Detection Sensor (can be disabled)
Others	Noise Level	≤32 dB (View mode at an ambient temperature of 25°C)
	Remote Control	Bluetooth Remote Control
	Indicator	White light
	Storage Temperature	-20°C to 55°C
	Operating Temperature	0°C to 40°C
	Operating Humidity	20%–80%

Troubleshooting

Fault	Solution
No projected image	Turn off the projector and disconnect from the power, then plug in the power cord and turn on the projector.
Android system crashes	Turn off the projector and disconnect from the power, then plug in the power cord and turn on the projector.
Screen display error	Turn off the projector and disconnect from the power, then plug in the power cord and turn on the projector.
Remote control is missing or not paired and the projector cannot be turned on remotely.	Turn off the projector and disconnect from the power. Wait for five minutes, then plug in the power cord and turn on the projector. After the projector has been restarted, pair the remote control again.
If the projector overheats, it will automatically turn off.	Please remove any obstacles from the air inlets and outlets so as to ensure a smooth airflow through the projector. Follow the instructions above to restart the projector.
Other Internal System Errors	Please contact a qualified technician to service the device, or return the projector to the after-sales department.

Product Certifications

HDMI™

HIGH-DEFINITION MULTIMEDIA INTERFACE

The terms HDMI, HDMI High-Definition Multimedia Interface, and the HDMI Logo are trademarks or registered trademarks of HDMI Licensing Administrator, Inc.



For DTS patents, see <http://patents.dts.com>. Manufactured under license from DTS Licensing Limited. DTS, the Symbol, DTS and the Symbol together, DTS-HD, and the DTS-HD logo are registered trademarks and/or trademarks of DTS, Inc. in the United States and/or other countries. © DTS, Inc. All Rights Reserved.



The Bluetooth word mark and logos are registered trademarks owned by Bluetooth SIG, Inc. and any use of such marks by [Xiaomi Inc.] is under license. Other trademarks and trade names are those of their respective owners.



Manufactured under license from Dolby Laboratories. Dolby, Dolby Audio, and the double-D symbol are trademarks of Dolby Laboratories.



Manufactured for: Xiaomi Communications Co., Ltd.

Manufactured by: Fengmi (Beijing) Technology Co., Ltd.

(a Mi Ecosystem company)

Address: 301, 3F, Building 3, No.10, Barracks South Street, Renhe Town, Shunyi District, Beijing, China

For further information, please go to www.mi.com