



Ninebot S-Max

User Manual

The manufacturer reserves the right to make changes to the product, release firmware updates, and update this manual at any time. Visit www.segway.com or check the Segway-Ninebot App to download the latest user materials. You must install the App to follow the New Rider Tutorial and activate your product before use.

CE.00.0044.34-C

ninebot[®]

Please read the user manual carefully before use, and keep it for future reference.

Contents

Welcome.....	01
1. Riding Safety	02
2. Packing List	04
3. Diagram	05
4. Assembling, Adjustment and Replacement.....	08
5. Charging	11
6. Activate the S-Max.....	12
7. Learning to Ride	13
8. Warnings and Cautions	15
9. Power-assist Mode.....	18
10. Specifications.....	19
11. Certifications.....	20
12. Maintenance.....	21
13. Trademark and Legal Statement.....	22
14. Contacts.....	24

WARNING

Please read the User Manual carefully and understand the assembly and usage before allowing child to ride it. Never use in roadways, near motor vehicles, on or near steep inclines or steps, swimming pools or other bodies of water; always wear shoes, and never allow more than 1 rider.

Welcome

Thank you for choosing the Ninebot S-Max.

Ninebot S-Max (referred to as S-Max in this manual) is a stylish recreational equipment. It is easy to operate and also can be assembled with the Ninebot Gokart Kit.

Enjoy your ride and connect with Segway riders worldwide!

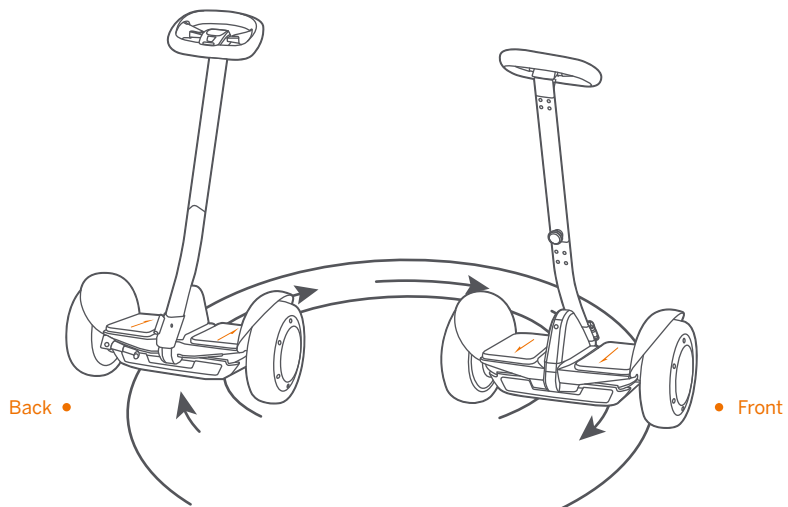

WARNING

Always step on/off from the back of the S-Max.
Otherwise you risk falls and/or collisions because the steering direction is reversed.

1 Riding Safety

1. S-Max is a recreational product. Before mastering riding skills, you need to practice. Neither Ninebot (means Ninebot (Beijing) Tech Co., Ltd. and its subsidiaries and affiliate) nor Segway Inc. is responsible for any injuries or damage caused by a rider's inexperience or failure to follow the instructions in this document.
2. Please understand that you can reduce the risk by following all the instructions and warnings in this manual, but you cannot eliminate all the risks. Remember that whenever you ride the S-Max you risk injury or death from loss of control, collisions, and falls. When entering into public spaces, always comply with the local laws and regulations. As with other vehicles, faster speeds require longer braking distance. Sudden braking on smooth surfaces could lead to wheel slip, loss of balance, or falls. Be cautious and always keep a safe distance between you and other people or vehicles when riding. Be alert and slow down when entering unfamiliar areas.
3. Always wear a helmet and other protective gear when riding. Use an approved bicycle or skateboard helmet that fits properly with the chin strap in place, and provides protection for the back of your head.
4. Do not attempt your first ride in any area where you might encounter children, pedestrians, pets, vehicles, bicycles, or other obstacles and potential hazards.
5. Respect pedestrians by always yielding the right of way. Pass on the left whenever possible. When approaching a pedestrian from the front, stay to the right and slow down. Avoid startling pedestrians. When approaching from behind, announce yourself and slow down to walking speed when passing. Please obey local traffic laws and regulations.
6. In places without laws and regulations governing self-balancing electric vehicles, comply with the safety guidelines outlined in this manual. Neither Ninebot nor Segway Inc. is responsible for any property damage, personal injury/death, accidents, or legal disputes caused by violations of the safety instructions.
7. Do not allow anyone to ride your S-Max on his/her own unless they have carefully read this manual, watched the safety video, and followed the New Rider Tutorial on the Segway-Ninebot App. The safety of new riders is your responsibility. Assist new riders until they are comfortable with the basic operation of the S-Max. Make sure each new rider wears a helmet and other protective gear.
8. Before each ride check for loose fasteners, and damaged components. If the S-Max makes abnormal sounds or signals an alarm, immediately stop riding. Diagnose your S-Max via the Segway-Ninebot App (referred to as the App in the manual) and contact your dealer/distributor for service.
9. Be alert! Scan both far ahead and in front of your S-Max — your eyes are your best tool for safely avoiding obstacles and low traction surfaces (including, but not limited to, wet ground, loose sand, loose gravel, and ice).
10. To reduce risk of injury, you must read and follow all "CAUTION" and "WARNING" notices in this document. Do not ride at an unsafe speed. Under no circumstance should you ride on roads with motor vehicles. The manufacturer recommends riders be 16+ years old. Always follow these safety instructions:
 - A. People who should not ride the S-Max include:
 - i. Anyone under the influence of alcohol or drugs.
 - ii. Anyone who suffers from a disease that puts them at risk if they engage in strenuous physical activity.

- iii. Anyone who has problems with balance or with motor skills that would interfere with their ability to maintain balance.
- iv. Anyone whose height or weight is outside the stated limits (see **Specifications**).
- v. Pregnant women.

B. Riders under the age of 16 years old should ride under adult supervision.

C. Comply with local laws and regulations when riding this product. Do not ride where prohibited by local laws.

D. To ride safely, you must be able to clearly see what is in front of you and you must be clearly visible to others.

E. Do not ride in the snow, in the rain, or on roads which are wet, muddy, icy, or that are slippery for any reason. Do not ride over obstacles (sand, loose gravel, or sticks). Doing so could result in a loss of balance or traction and could cause a fall.

F. Do not accelerate or decelerate suddenly. Do not accelerate when the S-Max tilts back or sounds an alarm. Do not attempt to override the speed limiter.

11. Do not attempt to charge your S-Max if it, the charger, or the power outlet is wet.
12. As with any electronic device, use a surge protector when charging to help protect your S-Max from damage due to power surges and voltage spikes. Only use the Segway supplied charger. Do not use a charger from any other product.
13. Use only Ninebot or Segway approved parts and accessories. Do not modify your S-Max. Modifications to your S-Max could interfere with the operation of the S-Max, could result in serious injury and/or damage, and could void the Limited Warranty.
14. Do not sit on the steering bar. Doing so could result in serious injury and/or damage to your S-Max.
15. Prolonged Exposure to UV Rays, Rain and the Elements May Damage the Enclosure Materials, Store Indoors When Not in Use.
16. **WARNING** – Risk of fire and electric shock – no user serviceable parts. Do not touch the metal contacts, dismantle or puncture the casing. Keep away from metal objects to prevent short circuit.
17. S-Max is not intended for use at elevations greater than 2000 m above sea level.

2 Packing List

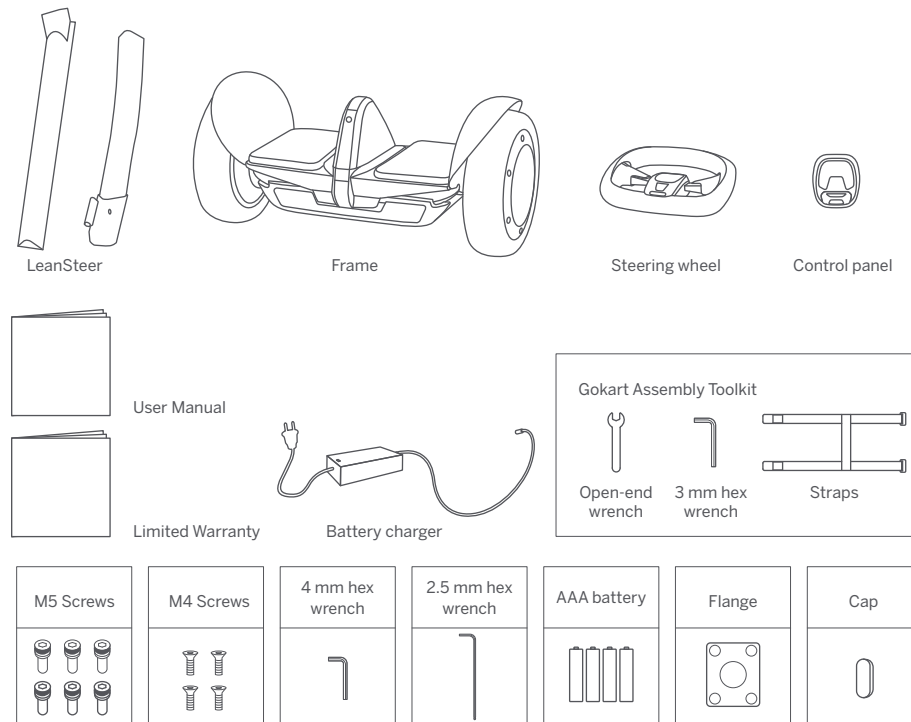

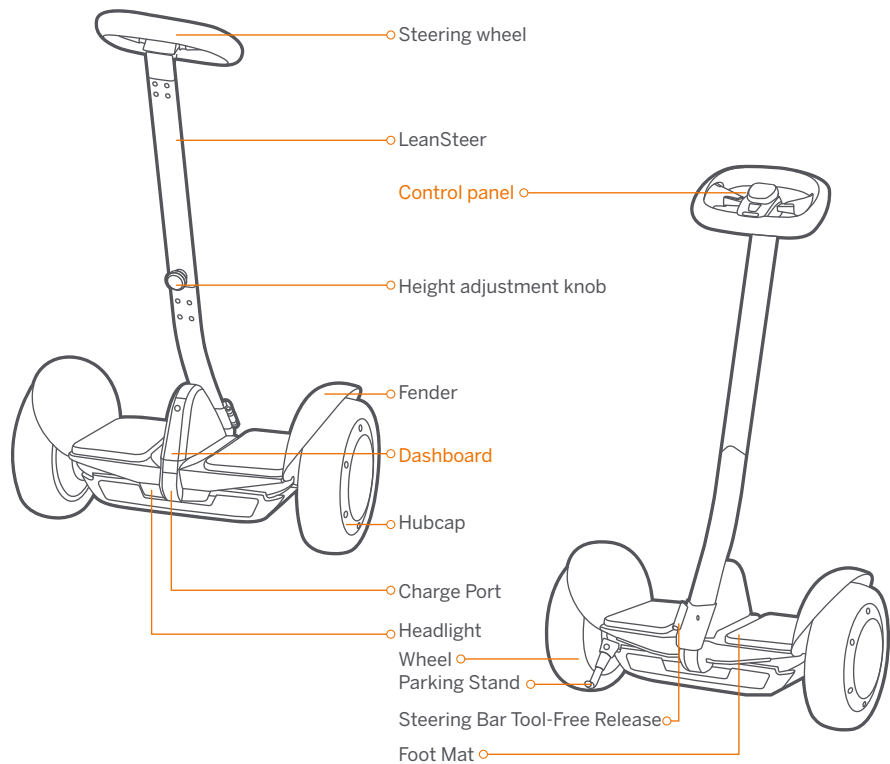

When unpacking your S-Max, please verify that the above items are included in the package. If you are missing any components, please contact your dealer/distributor or nearest service center. Please retain the box and packaging materials in case you need to ship your S-Max in the future. Always power off your S-Max and unplug from the power supply before cleaning.

3 Diagram



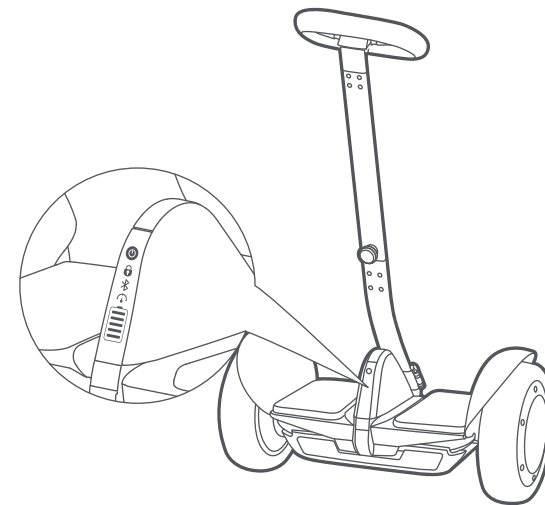
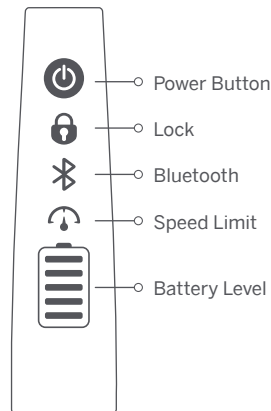

Dashboard



-  **Power Button** Press once to power on/off. The S-Max will automatically power OFF when idle for 10 minutes, or when lying horizontally for over 30 seconds.

-  **Lock** Enable Lock Mode via the App. The S-Max will vibrate and sound an alarm if anyone moves it. The remote control will also alarm if it is powered on and within range [65 ft. (20 meters)] of the S-Max.

-  **Bluetooth** When the App is connected to the S-Max, this icon will glow steadily. When Bluetooth is enabled—but not connected to a smart phone—this icon will blink.

-  **Speed Limit** Enable and adjust Speed Limit via the App. When the icon is illuminated, Speed Limit is on. This speed limit can be adjusted in the App. As you approach the speed limit, the S-Max tilts back.

-  **Battery Level** Indicates the remaining battery life. Each bar equates to approximately 20% battery level. When the battery is nearly empty, this icon blinks and the S-Max beeps, indicating that you need to charge your S-Max. Your S-Max will gradually reduce the max speed as the battery level gradually decreases. Use the App to view the remaining battery and estimated remaining range.

Control panel

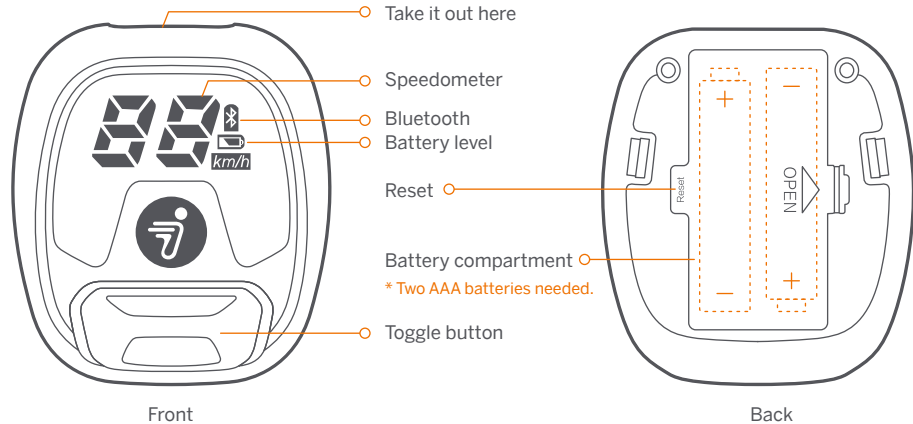

● Install the batteries

- ① Take the control panel out of the steering wheel.
- ② Open the battery cover and place in batteries.
- ③ Close the battery cover.

● Features

Toggle button:

- Toggle up or down to open the control panel; Press up or down to close it.
- Toggle up to increase the display's brightness; toggle down to reduce the brightness.

Speedometer: Displays the current speed of the S-Max.

Bluetooth: Flashing blue: Bluetooth is waiting to be connected.

Solid blue: the vehicle is connected to S-Max.

Battery level: Indicates the remaining battery of the control panel. When the battery is nearly empty, it appears red. Please replace the AAA batteries.

Reset: Long press this key to pair when the control panel is not connected with vehicle, or need to reconnect.

* The control panel and the App cannot be connected to the S-Max at the same time. If you have connected the S-Max to the app, disconnect it first, and then pair with the control panel.

4 Assembling, Adjustment and Replacement

Install the LeanSteer

- ① Insert the LeanSteer's upper section into the lower section, then tighten the four M4 screws with the 2.5 mm hex wrench.

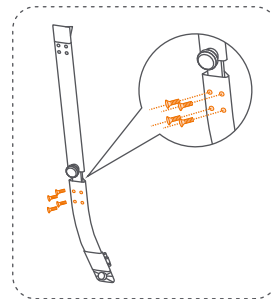

- ② Align the flange with the holes on the steering wheel and tighten it with four M5 screws with the 4 mm hex wrench.

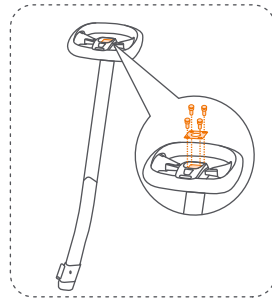

- ③ Open the battery cover of the control panel. Place in two AAA batteries. Snap the cover.

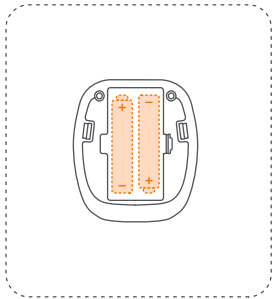

- ④ Press the control panel into the center of the steering wheel.

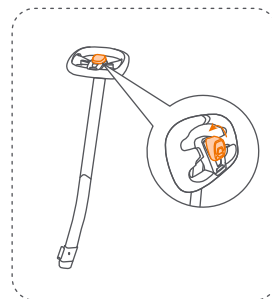

- ⑤ Insert the LeanSteer into the vehicle body and tighten the two M5 screws with the 4 mm hex wrench.

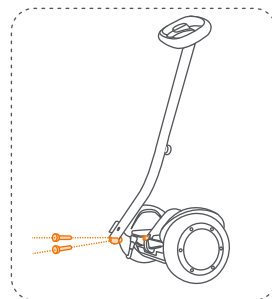

- ⑥ Secure the cap.

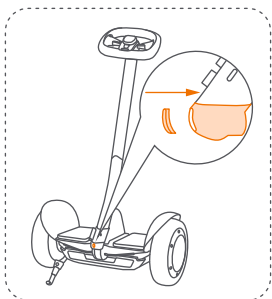

Adjust the Height

- 1 Rotate the height adjustment knob counter-clockwise.

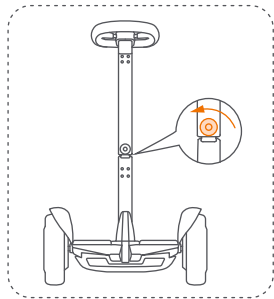

- 2 Lift the LeanSteer to the desired height. Rotate the knob clockwise to tighten.

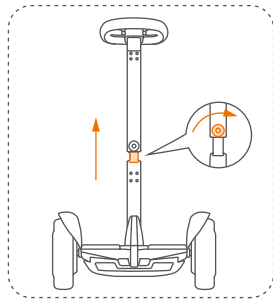

WARNING

After installing the LeanSteer, it is normal for the self-balancing vehicle to move forward or backward when powered on. Before parking, please power off the vehicle first.

Replace the straps

S-Max can be assembled with Ninebot Gokart Kit to become a go-kart. When assembling S-Max with Ninebot Gokart Kit, you need to replace the straps to fit the Gokart Kit.

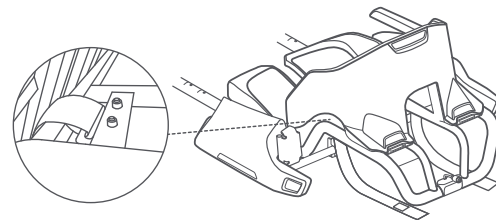

- 1 Use the open-end wrench to tighten the nut, then remove the two bolts on both sides with the 3 mm hex wrench.

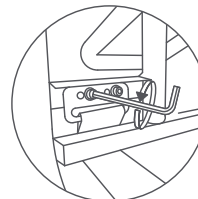

- 2 Place the straps with the logo side facing out.

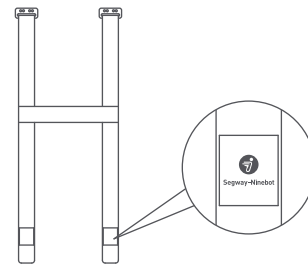

- 3 As shown below, pass the straps through the frame.

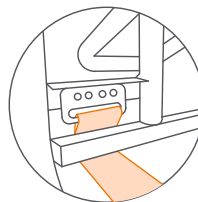

- 4 Tighten the nut and the four bolts.

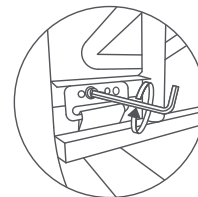

5 Charging

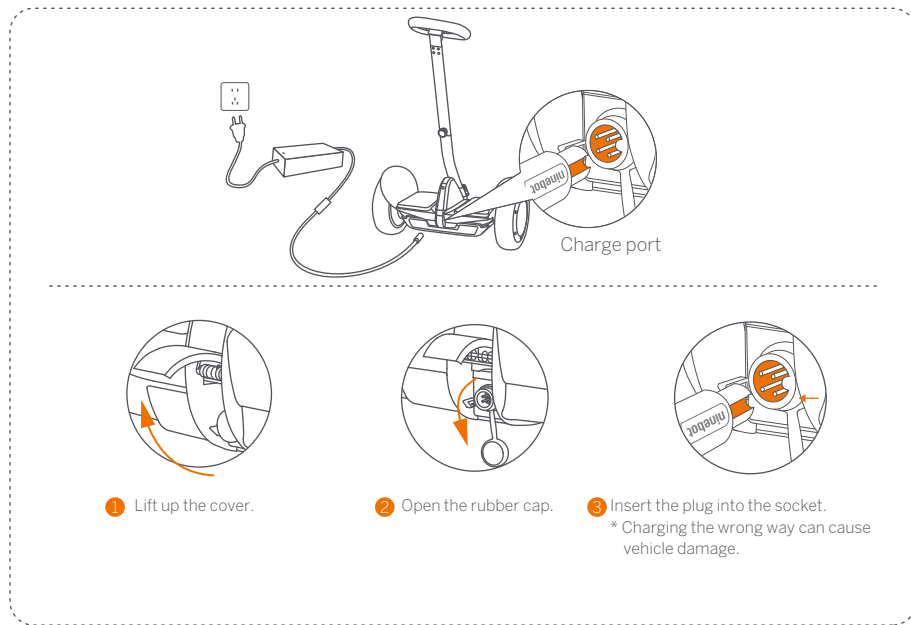

Your S-Max is fully charged when the LED on the charger changes from red (charging) to green (trickle charge).

WARNING

ONLY use the original charger, otherwise the battery will be damaged and there is a risk of fire. Do not use or charge your battery if the battery is damaged or see a trace of water. DO NOT charge when the charge port or cable is wet.

6 Activate the S-Max



Segway-Ninebot App

There are safety risks when learning to ride the S-Max. You must read the Safety Instructions and follow the New Rider Tutorial in the App before your first ride. For your safety, your S-Max is not activated at this time and will beep occasionally after Power ON. Until activated, the S-Max maintains a very low riding speed and steering sensitivity. Install the App on your mobile device (with Bluetooth 4.1 or above), connect to the S-Max with Bluetooth, and follow the App instructions to activate your S-Max and follow the training procedures. Scan the QR code to download the App.

1 Install the App and register or log in.

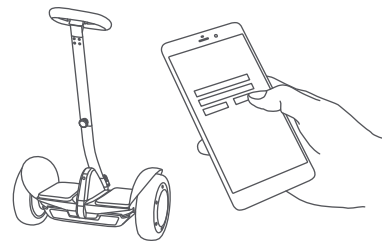

3 Click Device > Search Vehicle to connect to your S-Max. The S-Max will beep when the connection is successful. The Bluetooth icon will stop blinking and remain illuminated.

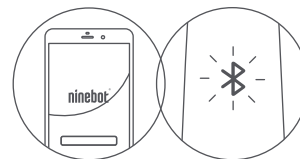

2 Power ON the S-Max. The Bluetooth icon blinking indicates the S-Max is waiting for a connection.

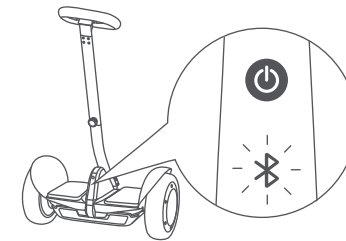

4 Follow the prompts to watch the Riding Safety video, complete the New Rider Tutorial, and then activate the S-Max.



* The control panel and the App cannot be connected to the S-Max at the same time. If you have connected the App, disconnect the App from the S-Max first, and then pair the control panel.

7 Learning to Ride



16–60 years old
88.2–137.4 lbs (40–85 kg)
51.2–78.7 in (130–200 cm)

Wear an approved helmet and other protective gear to minimize any possible injury.

Note: Minors must study and ride under the supervision of their guardians.

After activation, the App will lead you through the New Rider Tutorial. Please follow the instructions in the App and in this manual.

For your safety, the S-Max will limit the max speed to 4.3 mph (7 km/h) until you complete the New Rider Tutorial.

After completing the New Rider Tutorial, the max speed will be limited to 6.2 mph (10 km/h).

For the first 0.6 miles (1 km) completed, you can disable the speed limiter via the App and reach a maximum speed of S-Max (see specifications).

*** The actual speed limit will be increased or decreased depending on your riding habits and experience.**

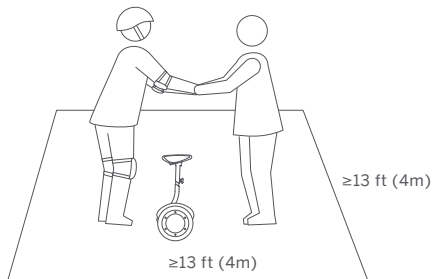

- 1 Go to a large open area and ask a friend to assist you on your first ride.
*** Always step on/off from the back of the vehicle.**

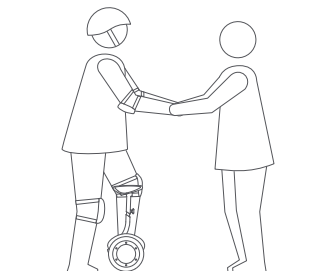

- 2 Lightly place one foot on the foot plat, while keeping your other foot on the ground holding your weight. Do not press the steering bar with your leg.

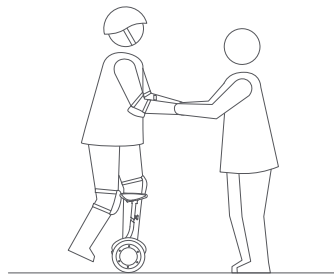

- 3 Slowly transfer your weight onto the S-Max. The S-Max will beep, indicating it is now in Balance Mode. Slowly step on with your other foot.

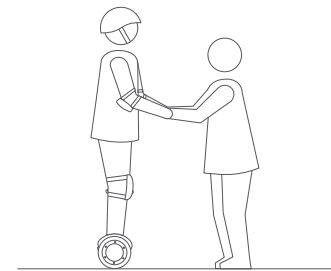

- 4 Stand with your weight evenly distributed on both feet and relax, looking straight ahead.

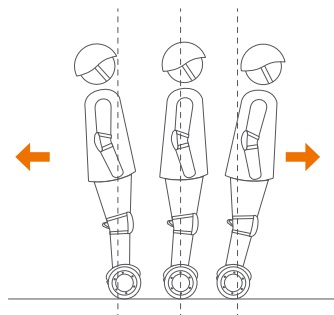

- 5 Gently lean your body forward and backward to control your movement.

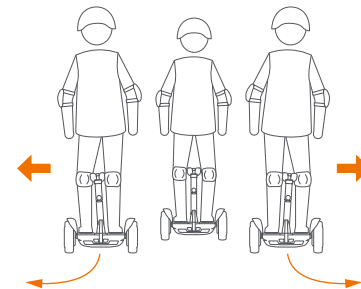

- 6 To turn, gently lean left or right against the steering bar.

8 Warnings and Cautions

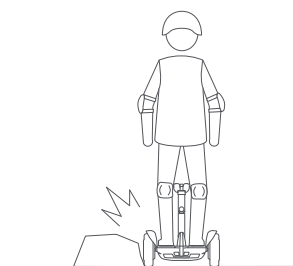

! Avoid contacting obstacles with the tire/wheel.

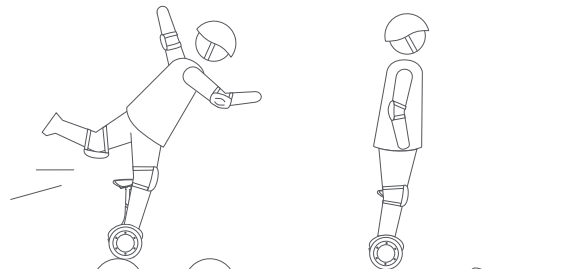

! When traversing small bumps or uneven terrain, maintain a moderate speed of 2–6 mph (3–10 km/h) and keep your knees bent. Do not go too slow or too fast; otherwise, you may lose control and fall.

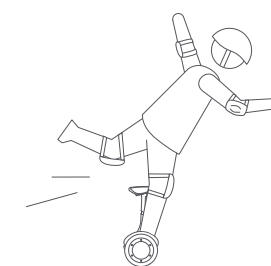

! DO NOT attempt stunts of any kind. Always keep both feet on the foot mats.

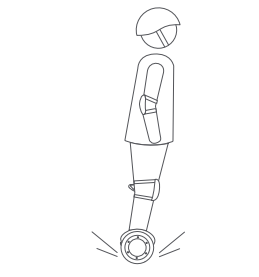

! Maintain contact with the ground at all times. Do not jump or attempt stunts.



! DO NOT ride on low traction surfaces (including, but not limited to, wet ground, loose sand, loose gravel, and ice).

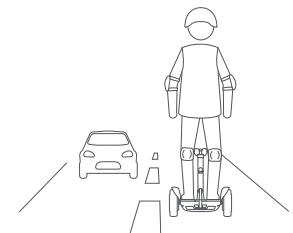

! DO NOT ride on public roads, motorways, or highways unless the local laws or regulations have exceptions.

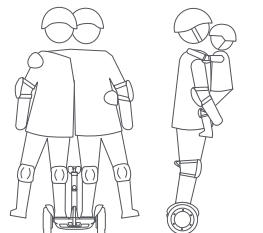

! For one rider only. DO NOT ride double or carry any passengers. DO NOT carry a child.

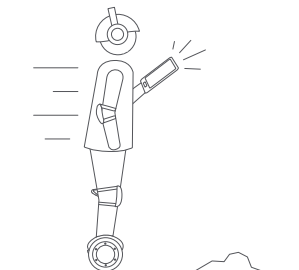

! DO NOT use a mobile phone or wear earphones when riding.

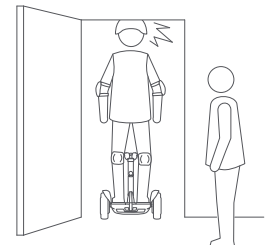

! Watch your head when passing through doorways.

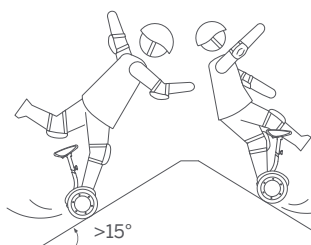

! Avoid slopes steeper than 15°.

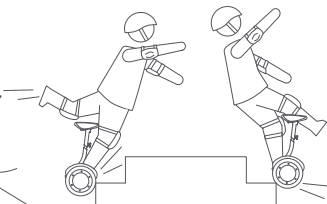

! DO NOT ride over holes, curbs, steps, or other obstacles.



You must read and understand the Warnings and Safe Riding instructions in this manual before attempting to ride the vehicle. Failure to follow these warnings could result in death or serious injury due to: loss of balance, traction, and/or control collisions and falls.

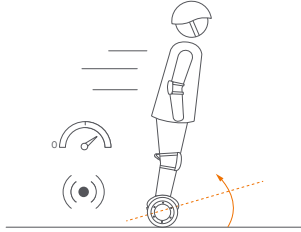

DO NOT accelerate when the vehicle tilts back or sounds an alarm (speed limiter). Do not attempt to override the speed limiter.

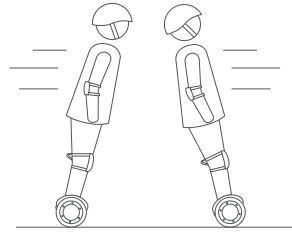

DO NOT accelerate or decelerate abruptly. Do not lean more than 5° or accelerate/decelerate faster than 2.5 mph/s (4 km/h/s).

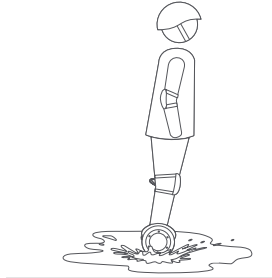

DO NOT ride through puddles or other bodies of water. Do not get wet.

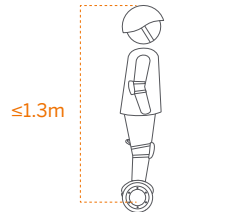

The rider must be more than 1.3 m in height and 40 kg in weight.

9 Power-assist Mode

The Power-assist mode is helpful to push and move the S-Max. It is disabled as factory default. You can enable it in the App under "Vehicle" > "Power-assist mode".

* When Power-assisted mode is on, please hold the steering wheel to avoid moving away. Otherwise, S-Max will move forward or backward automatically due to the center of gravity.

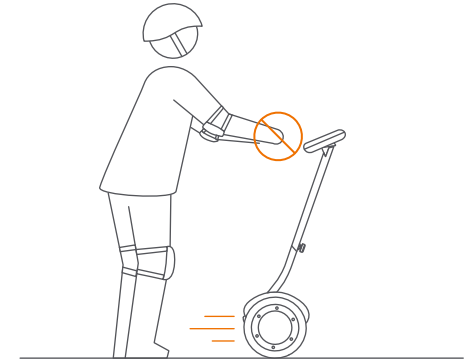
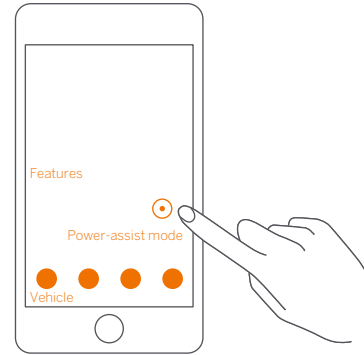

10 Specifications

	Item	Parameter
Product	Name	Ninebot S-Max
	Model	N3M432
	Dimensions ^[1]	(16.6–20.5) × 22.8 × (37.5–48.9) inch / (421–521) × 578 × (952–1242) mm ^[1]
Weight	Payload	88.2–220 lbs / 40–100 kg
	Net Weight	Approx. 50.3 lbs (22.8 kg)
Rider	Age	16–60 years old
	Height	51.2–78.7 in / 130–200 cm
Machine Parameters	Max. Speed	Approx. 12.4 mph (20 km/h)
	Typical Range ^[2]	Approx. 23.6 miles (38 km)
	Max. Slope	Approx. 15 °
	Traversable Terrain	Pavement, packed dirt, slopes < 15 °, obstacles < 0.4 in (1 cm), gaps < 1.2 in (3 cm)
	Operating Temperature	14–104°F (-10–40°C)
	Storage Temperature	-4–122°F (-20–50°C)
	IP Rating	IP54
Battery	Charge Time	Approx. 4 hours
	Nominal Voltage	55.5 V DC
	Max. Charging Voltage	59.5 V DC
	Nominal Energy	432 Wh
	Charging Temperature	32–104°F (0–40°C)
Motors	Battery Management System	Over-voltage, under-voltage, short circuit, and over-heating protection, Auto-sleep and auto-wake.
	Nominal Power	500 W × 2
Charger	Max. Power	2400 W × 2
	Input Voltage	100–240 VAC
	Output Voltage	59.5 VDC
	Nominal Power	120 W
Tire	Output Current	2 A
	Tire	Tire width: 2.7 in (68 mm); 10 × 2.75 in, hollow solid tire

[1] The two values in brackets are the lowest distance from the ground to the highest part of the mainframe.

[2] Typical Range: tested while riding under full power, 165 lbs (75 kg) load, 77°F (25°C), 60% of max. speed on average on pavement.

* Some of the factors that affect range include: speed, number of starts and stops, ambient temperature, etc.

11 Certifications

This product is certified to ANSI/CAN/UL-2272 by TUV Rheinland.

The battery complies with UN/DOT 38.3.

The battery complies with ANSI/UL 2271.

Federal Communications Commission (FCC) Compliance Statement for USA

This device complies with part 15 of the FCC rules. Operation is subject to the following two conditions: (1) This device may not cause harmful interference, and (2) this device must accept any interference received, including interference that may cause undesired operation.

NOTE

This equipment has been tested and found to comply with the limits for a Class B digital device, pursuant to part 15 of the FCC Rules. These limits are designed to provide reasonable protection against harmful interference in a residential installation. This equipment generates, uses and can radiate radio frequency energy and, if not installed and used in accordance with the instructions, may cause harmful interference to radio communications. However, there is no guarantee that interference will not occur in a particular installation. If this equipment does cause harmful interference to radio or television reception, which can be determined by turning the equipment off and on, the user is encouraged to try to correct the interference by one or more of the following measures:

- Reorient or relocate the receiving antenna.
- Increase the separation between the equipment and receiver.
- Connect the equipment into an outlet on a circuit different from that to which the receiver is connected.
- Consult the dealer or an experienced radio/TV technician for help.

This equipment complies with FCC radiation exposure limits set forth for an uncontrolled environment.

This equipment should be installed and operated with minimum distance 20cm between the radiator & your body.

Cet équipement est conforme aux limites d'exposition aux radiations de la IC définies pour un environnement non contrôlé. Cet équipement doit être installé et utilisé à une distance minimale de 20 cm entre le radiateur et votre corps.

Industry Canada (IC) Compliance Statement for Canada

This device complies with Industry Canada license-exempt RSS standard (s). Operation is subject to the following two conditions: (1) this device may not cause interference, and (2) this device must accept any interference, including interference that may cause undesired operation of the device.

CAN ICES-3 (B)/NMB-3(B)

"Le présent appareil est conforme aux CNR d'Industrie Canada applicables aux appareils radio exempts de licence. L'exploitation est autorisée aux deux conditions suivantes : (1) l'appareil ne doit pas produire de brouillage, et (2) l'utilisateur de l'appareil doit accepter tout brouillage radioélectrique subi, même si le brouillage est susceptible d'en compromettre le fonctionnement."

Neither Segway Inc. nor Ninebot is responsible for any changes or modifications not expressly approved by Segway Inc. or Ninebot. Such modifications could void the user's authority to operate the equipment.

FCC ID: 2ALS8-PS0002
IC: 22636-PS0002

12 Maintenance

Cleaning and Storing

Use a soft, wet cloth to wipe the mainframe clean. Hard to remove dirt can be scrubbed with a toothbrush and toothpaste, then cleaned with a soft, wet cloth. Store your vehicle in a cool, dry place. Do not store it outdoors for extended periods of time.

Exposure to sunlight and temperature extremes (both hot and cold) will accelerate the aging process of the plastic components and may reduce battery life.



WARNING

Do not wash your Gokart Pro or S-Max with alcohol, gasoline, acetone, or other corrosive/volatile solvents. These substances may damage the appearance and internal structure of the vehicle. Do not wash your vehicle with a power washer or high pressure hose.

Make sure the Gokart Pro or S-Max is powered OFF, the charging cable is unplugged, and the rubber cap on the charge port is tightly sealed before cleaning; otherwise you may expose yourself to electric shock or damage the electronic components.

Battery Pack Maintenance

- Do not use battery packs of other models or brands, otherwise there may be safety risks.
- Only use a Ninebot or Segway approved charge cable. Please use it properly within the rated range.
- Do not place the battery pack in the fire. Doing so will cause battery failure, overheating or even fire and explosion.
- Do not store or charge the battery at temperatures outside the stated limits (see **Specifications**).
- Do not discard or destroy the battery. Refer to your local laws and regulations regarding battery recycling and/or disposal.
- Remember to charge the battery after each use. Completely draining the battery may cause permanent damage to the battery.

NOTE

Typically, a fully charged battery should retain charge for 120-180 days when in standby. Electronics inside the battery record the charge-discharge condition of the battery; damage caused by over-discharge or under-discharge will not be covered by the Limited Warranty.

A well-maintained battery can perform well even after many miles of riding. Charge the battery after each ride and avoid draining the battery completely. When used at room temperature (70°F [22°C]) the battery range and performance is at its best; whereas using it at temperatures below 32°F (0°C) can decrease range and performance. Typically, at -4°F (-20°C) range can be half that of the same battery at 70°F (22°C). The battery range will recover when the temperature rises. More details are available in the App.



WARNING

Do not attempt to disassemble the battery. Risk of fire. No user-serviceable parts. Do not ride when the ambient temperature is outside the operation temperature (see Specifications) because low/high temperatures will limit the maximum power/torque. Doing so could cause personal injury or property damage due to slips or falls.

13 Trademark and Legal Statement

Ninebot is the registered trademark of Ninebot (Tianjin) Tech Co., Ltd; Segway - the Rider Design and Powered by Segway are the registered trademarks or trademarks of Segway Inc.. Bluetooth is the registered trademark of BLUETOOTH SIG, INC.; Android, Google Play are trademarks of Google Inc., App Store is a service mark of Apple Inc., The respective owners reserve the rights of their trademarks referred to in this manual.

We have attempted to include descriptions and instructions for all the functions of the Ninebot S-Max at the time of printing. However, due to constant improvement of product features and changes of design, your Ninebot S-Max may differ slightly from the one shown in this document. Visit the Apple App Store (iOS) or the Google Play Store (Android) to download and install the App.

Please note that there are multiple Segway and Ninebot models with different functions, and some of the functions mentioned herein may not be applicable to your unit. The manufacturer reserves the right to change the design and functionality of the Ninebot S-Max product and documentation without prior notice.

© 2020 Ninebot (Beijing) Tech Co., Ltd. All rights reserved.

Legal Statement:

The user shall agree to read the entire user manual and fully understand its content (especially the parts related to warnings and caution statements) and adhere to the instructions herein before riding this product.

1. This product can be dangerous to a user, other persons and property in proximity thereto. The user shall assume all the risks and loss in connection with the product (especially for those related to and/or arising out of violation of the instructions about warnings and caution statements). Such risks include but not limited to loss of control, failure of the product and/or collusion) The consequences for such incident can be severe, including but not limited to injuries, bodily injuries, death and/or damages to property. NINEBOT and its affiliates shall not be liable for any claim, liability and loss related to such consequences, if it is due to the user's assumption of risk.

2. The product is a means for entertainment and the user may have necessary and sufficient experience and skills to ride it, especially in complex environments and/or undesirable road. Such risk may increase if the user has physical and/or mental impairment or disability, or a user is under the influence of alcohol, drugs or similar substance. Such risk may also increase if the user is not sufficiently familiar with the functions, features and performance of the product. Thus, the user, especially new users shall learn and practice how to ride this product properly and safely. Experience accumulated by practice would normally enable a user to better ride and operate the product by time.

3. The parts and components of the product are subject to fatigue, wear and tear ("Wear and Tear"). Many factors, such as environment, aging road conditions and/or riding behaviors may affect the rate of Wear and Tear. Wear and Tear may cause unanticipated and/or sudden failure of the product, which may cause, inter alia, severe bodily injury. So, the user shall regularly and periodically, as the circumstance requires, inspect and maintain the product. The user shall also conduct reasonable examination and inspection of the product every time before riding it. For instance, every time before riding the product, the user shall check and examine tire performance, battery level, brake (including brake cable and that the brake shall have proper tension), installation status and all functional parts. If abnormality, discoloration or change of color of material

(especially in an area that receives high stress when the product is in motion or junction) . scratch, crack, loose fasteners, and/or missing parts (such as screw, bolts and/or nut) which strongly indicates that it is not safe to ride the product.

4. Since it is impossible to predict and/or anticipate all and every scenario, condition and/or circumstances under which a product user may be exposed to risk and danger, the User Manual is not intended to be an exhaustive list on how to ride the product safely and/or avoid hazards related to the product. So, in addition to adhere to the instructions, the user shall also ride and/or use the product with responsibility, carefulness, precaution and best judgment. The users should always be a responsible rider cautious, maintain proper speed and avoid all dangerous riding behaviors when riding the product. For instance, the users shall avoid speeding, overloading or performing stunts of any kind. Do not try to touch the tires with your hands or feet when riding. One rider only.

5. The users shall check and obey the local laws or regulations over the product. It is the sole user's responsibility that he/she shall ride, use and/or dispose of the product in compliance with the law. The law and regulations may be different in different jurisdictions. Apart from the others, such laws and regulation may include:

(1) A helmet may be legally required by local law or regulation in your jurisdiction.

(2) Your S Max is not be allowed to be driven in motorway or highway.

You may obtain more information related to legal requirements on S Max from your local government.

6. The user shall immediately check whether the product and its accessories are in good condition upon receipt of the product.

7. All the separate components and part of the products must be properly installed per the User Manual. Inappropriate installation and/or assembly may significantly increase the risk of loss of control, product failure, collisions and falls. The product may contain removable components and small parts. Please keep them out of the reach of children to avoid choking hazard.

8. Do not dispose of this product in a landfill, by incineration, or by mixing with household trash. Serious danger/ injury can occur because of the electrical components and the battery. For information about battery and electrical waste, please contact your household waste disposal service, your local or regional waste management office, or your point-of-sale. The user shall not use any non-original accessories, or dismantle or modify the product without authorization. All damages, injuries and damages to property arising therefrom will be your sole responsibility and risk.

9. NINEBOT reserves the right to make changes to the product, release firmware updates, and update this manual at any time. Improvements and changes to this user manual necessitated by typographical errors, inaccuracies of current information, or improvements to programs and/or equipment, may be made by NINEBOT at any time and without notice. Such changes will, however, be incorporated into new editions of this user manual. All illustrations are for illustration purposes only and may not accurately depict the actual device. Actual product and functions may vary. Due to the update of the product, there may be some deviations in color, appearance and other aspects between the product listed in this manual and the product you purchased. Please refer to the actual product.

10. This document should be considered as a permanent part of the product and it shall be provided to the user together with the product all the time.

Thank you again for choosing Ninebot S-Max!

14 Contact

Contact us if you experience issues relating to riding, maintenance and safety, or errors/faults with your S-Max.

Americas:

Segway Inc.

14 Technology Drive, Bedford, NH 03110, USA

Toll Free: 1-866-473-4929

Fax: 1-603-222-6001

Technical Support Email: technicalsupport@segway.com

Website: www.segway.com

Have your S-Max serial number on hand when contacting Segway.

You can find your serial number on the underside of your S-Max or in the App under More Settings > Basic Information.